

DENAFRIPS

PONTUS 15th user's manual

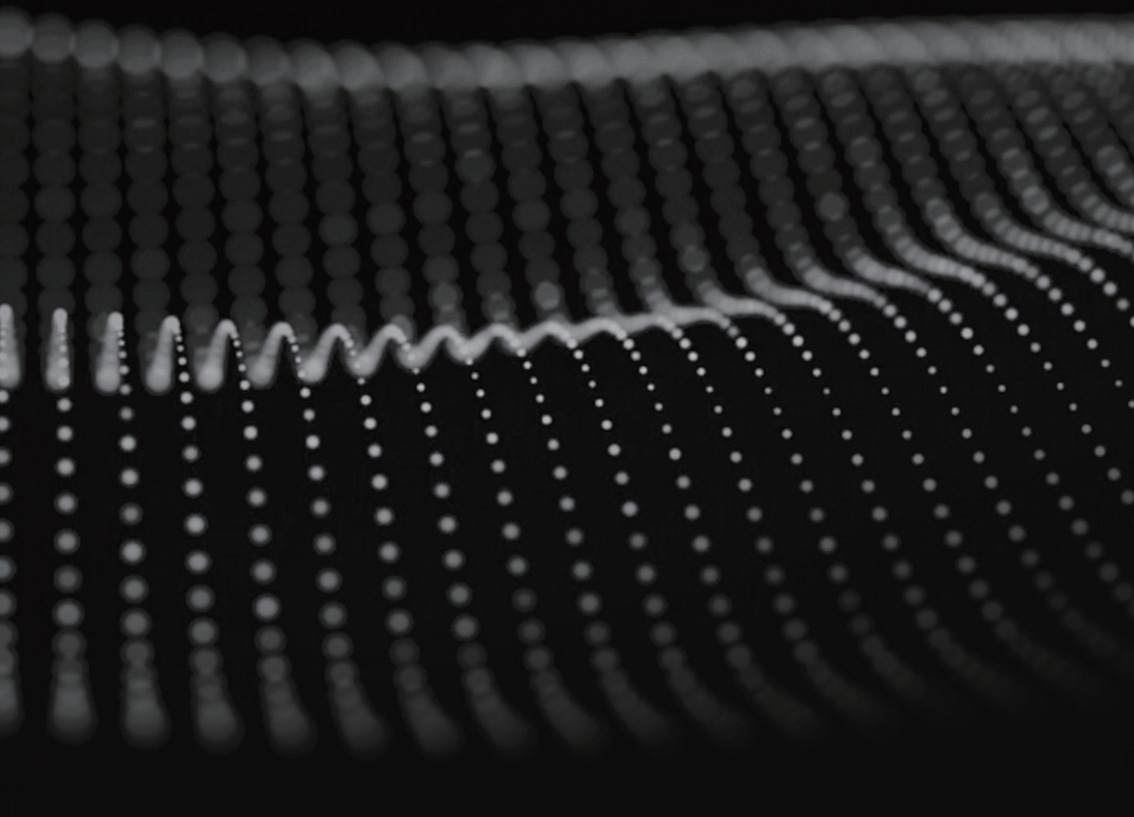

Table of Contents

Product Overview.....	3
Function Panel Introduction.....	6
Operation Settings.....	10
technical specification.....	14
Backplane Interface Introduction.....	15
USB Driver Installation.....	17
Common Troubleshooting.....	18
after-sales service.....	20
Important protective measures to be aware of.....	22

Product Overview

The PONTUS 15th is the fourth iteration of the PONTUS series. Since its introduction, each upgrade has been favoured by music lovers around the world due to its excellent price/performance ratio and outstanding performance. This time, the PONTUS 15th upgrade has not changed much on the exterior, still using the aluminium chassis and sheet metal chassis. However, the internal architecture has been significantly upgraded, optimising the circuitry and perfecting the R2R architecture. The unit is equipped with fully balanced R2R circuits, high-speed multi-channel digital isolators, and multiple sets of R2R array resistors and triggers for precise D/A conversion. The use of a dual power supply system with a high quality LDO chip ensures stable signal transmission.

The PONTUS 15th also employs two in-line, full-size, high-precision custom crystals that The stability of the clock for the machine provides a solid guarantee to ensure the accuracy of high-speed digital signals, accurate clock, is a solid foundation for FPGA algorithms, in order to be able to perfectly play a variety of sample rates and a variety of audio formats. In addition, the machine is equipped with dual O-shaped transformers, fully isolated dual power rectifier filter circuit, as well as customised WIMA, EVOX, EPCOS and other high-quality capacitors to further enhance the sound quality.

In terms of sound performance, PONTUS 15th sound performance is more delicate, the low frequency is elastic, thick and powerful; the mid-frequency is full; and the high frequency is translucent and natural, which makes the listening experience more pleasurable and relaxing.

Functional features

- ①. Proprietary R2R architecture.
- ②. True fully balanced 26bit R2R + 6bit DSD (32 stage FIR filter).
- ③. Multiple high-precision resistors are used in the R2R line.
- ④. Special 45.1548MHz, 49.152Mhz high-precision active crystal with low phase noise.
- ⑤. Adaptive FIFO clock buffer.
- ⑥. Optimised FPGA digital signal processing algorithm.
- ⑦. USB and I2S input audio source sample rate up to DSD1024, PCM1536KHz.
- ⑧. The USB audio solution is implemented by high-speed ARM MCU.
- ⑨. Licensed Thesycon USB driver for Windows platform.
- ⑩. No driver is required for Mac and Linux.
- ⑪. 7 types of digital input sources, including AES can be humanely set to single & dual AES input mode.
- ⑫. Fast/slow roll-off filter is selectable.
- ⑬. The I2S input pin has 8 modes to choose from, which is perfectly compatible with all major brands of audio sources and DDC devices on the market.
- ⑭. When I2S plays DSD signals, you can swap the left and right channels through the function settings.
- ⑮. Digital Receiving Processing and R2R circuit part, each adopts one O-shaped transformer to provide superb power supply capability, and adopts multiple low-noise LDOs.
- ⑯. The unit has custom-made high quality electrolytic capacitors, and a variety of incoming complementary film capacitors.
- ⑰. Power shielding box inside the machine, which helps to shield electromagnetic interference, all-aluminium remote control.

DSD

- ①. OPT, COAX, AES support DSD64–DoP.
- ②. USB and I2S inputs support up to DSD1024.

PCM

- ①. OPT, COAX, AES support 44.1KHz–192KHz.
- ②. USB input supports 44.1KHz–1536KHz.
- ③. I2S input supports 44.1KHz–768KHz.

sampling mode

Original code rate NOS/over–sampling OS.

Panel Function Introduction

Figure 1

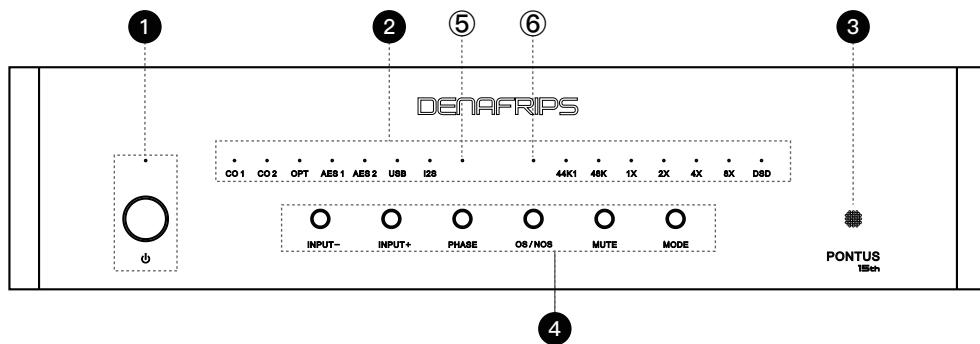

① Standby button and indicator

When the power of the unit is turned on, the standby indicator light is on, indicating that it is in standby mode. Press the standby button, the standby indicator goes out and the DAC starts to work.

② Indicators on the DAC panel (showing input source, sample rate, audio format and mode).

a. Signal Source Indicators: CO1, CO2, OPT, AES1, AES2, USB, I2S. These indicators represent the different input ports. When an input source is selected, the corresponding indicator will light up.

b. Sample Rate Indicators: 44.1K (44.1 KHz sample rate); 48K (48 KHz sample rate). These indicators indicate the current sampling rate of the input audio signal.

c. Multiplier Indicators: 1X (original sample rate); 2X (2 times the sample rate); 4X (4 times the sample rate); 8X (8 times the sample rate). These indicators indicate the multiplier of the current input audio signal (e.g., a multiple of the original sampling rate, as described in the chart below).

d. Audio Format Indicator: DSD when the light is on, PCM when the light is off.

e. PHASE indicator: in-phase when the light is on, inverted when the light is off.

f. OS/NOS indicator: NOS when the light is on, OS when the light is off.

In OS mode, the DAC processes the incoming digital audio signal to increase the sampling rate. Oversampling adds more data points through an interpolation algorithm that thereby improving the audio quality.

In NOS mode, the DAC processes the input digital audio signal directly without any sample rate processing. This mode preserves the audio signal's original characteristics of the audio signal.

③. Remote control receiving window

The remote control receiving signal window , cannot be blocked, otherwise it will affect the remote control receiving signal.

Kind Reminder: The DAC device does not come with a remote control, which needs to be purchased separately.

Schematic diagram of the effective working angle and distance range of the remote control.

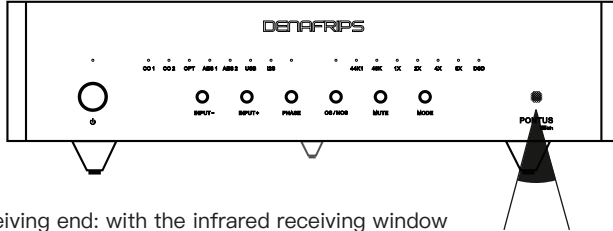

Receiving end: with the infrared receiving window as the axis of the Plus or minus 30 degrees cone range;

Effective remote control Distance: $\leq 8m$

Transmitter: A conical range of ± 10 degrees centered on the infrared emitter.

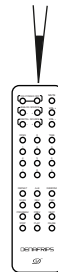

4. control key

a. INPUT-, INPUT+, PHASE, OS/NOS, MUTE, MODE. press these buttons for direct control of the audio input source, phase, sample mode, mute and operating mode.

b. Description of each key



① in Fig. 1) Standby button: press the standby power button, the standby indicator in Fig. 1 goes off and the DAC starts to work; on the contrary, the lamp is on, indicating that the DAC is handles the standby state.

INPUT- button: Selects or switches to the previous input source.

INPUT+ button: Selects or switches to the next input source.

PHASE Button: Phase selection switch. When this button is pressed, the light ⑤ in Figure 1 illuminates for in-phase output, and turns off for out-of-phase output.

OS/NOS button: Source and oversampling selector switch, when this button is pressed, ⑥ in Fig. 1 is NOS when the light is on, and OS when the light is off.

MUTE button: When this button is pressed, all source indicators are flashing.

MODE button: Used to switch between different preset modes.

The relationship between the sampling rate of the input audio signal and the display of the panel indicators is shown in Table 1 below.

Basic Sampling Rate	multiplier	input format
44.1 KHz	1X	44.1 KHz
	2X	88.2 KHz
	4X	176.4 KHz
	8X	352.8 KHz
	16X = 2X + 8X	705.6 KHz
	32X = 4X + 8X	1411.2 KHz
48 KHz	1X	48 KHz
	2X	96 KHz
	4X	192 KHz
	8X	384 KHz
	16X = 2X + 8X	768 KHz
	32X = 4X + 8X	1536 KHz
DSD	1X	DSD 64
	2X	DSD 128
	4X	DSD 256
	8X	DSD 512
	16X = 2X + 8X	DSD 1024

Operation Settings

Table 2

Function Setting	procedure
<p>A. USB upgrade settings</p>	<ol style="list-style-type: none"> 1. Please download the USB upgrade firmware from the official website first, open the storage location on your computer and find the ****.bat file. 2. Let the machine connected to the mains and in standby mode, only the standby light is on. 3. Connect one end of the USB cable to your computer and one end to the machine's USB audio source. 4. Open the *.bat file on your computer and the upgrade screen will appear. 5. In standby mode, press the 'MODE' button, and the 'USB' source indicator will flash, indicating that the firmware is being updated. Once the USB firmware update is successful, the message 'Firmware update successful' will appear on the computer screen. 6. Unplug the power cord, then plug the power cord, the machine is in standby mode, press the standby button, the machine will start, the USB firmware will be upgraded successfully.
<p>B. Dual AES input (Single AES mode illuminates only one source lamp; In dual AES mode, the AES1, AES2 lamps are lit at the same time)</p>	<ol style="list-style-type: none"> 1. The audio source is selected at AES1 or AES2. 2. Press the MUTE button to enter configuration mode. 3. Instantly switch the INPUT+ button (within 2 seconds) AES1 light = single mode; AES1, AES2 lamps on simultaneously = Dual AES mode; 4. wait 10 seconds. 5. AES mode of DAC is set successfully, and other functions are restored to their original state.

Function Setting	procedure
<p>C. Filter Selection (valid only in the operating system)</p>	<ol style="list-style-type: none"> 1. Press the MUTE button to enter configuration mode. 2. Switch the MODE button momentarily (within 2s) <ul style="list-style-type: none"> 1x Lamp off = Slow filter 1x light on = fast filter 3. Wait 10 seconds. 4. The DAC filter is set successfully and all other functions are restored to their original state.
<p>D. I2S Pin Configuration (Note: turn down the volume before configuring the pins)</p>	<p>Key Point: Please first confirm the I2S PINOUT diagram, then determine which wiring sequence mode (from mode 1 to 8) in the diagram below is required for I2S. The LED lights represent binary 000–111, with '○' indicating the light is off and '●' indicating the light is on. Pay attention to the on/off state of the three lights. The factory default setting for this unit is mode '1'.</p> <ol style="list-style-type: none"> 1. Select I2S Input 2. Press the MUTE button to enter the configuration mode. 3. After pressing PHASE button momentarily (within 2s), 1X , 2X , 4X lamps will be on/off, after pressing PHASE button repeatedly again, these 3 lamps will be on/off in fixed mode, you can stop the operation immediately after selecting the required matching mode (see I2S pin diagram for details), if you miss the required mode, follow the above steps to do it again. 4. Wait for 10 seconds. 5. The I2S setting of DAC is successful, and other functions are restored to their original state.

Function Setting	procedure
E. Selection Oversampling Rate/ Original Code Rate	<ol style="list-style-type: none"> 1. Press the OS/NOS button. 2. NOS lamp on = original code rate, NOS lamp off = oversampling rate.
F. DSD left and right channel switching	<ol style="list-style-type: none"> 1. Press the MUTE button to enter configuration mode. 2. Switch the NOS button momentarily (within 2s) for DSD left and right channel swap.

Table 3: I2S Pin Diagram (The machine is shipped in mode ‘1’, all lamps are off, ‘○’ = lamps off, ‘●’ = lamps on)

Mode	LED on & off Relationship Diagram			I2S PINOUT						
	1X	2X	4X	PIN	DATA		BCK		LRCK	9
	DATA	BCK	LRCK	Mode	1	3	4	6	7	
1	○	○	○	1	DATA-	DATA+	BCK+	BCK-	LRCK-	LRCK+
2	●	○	○	2	DATA+	DATA-	BCK+	BCK-	LRCK-	LRCK+
3	○	●	○	3	DATA-	DATA+	BCK-	BCK+	LRCK-	LRCK+
4	●	●	○	4	DATA+	DATA-	BCK-	BCK+	LRCK-	LRCK+
5	○	○	●	5	DATA-	DATA+	BCK+	BCK-	LRCK+	LRCK-
6	●	○	●	6	DATA+	DATA-	BCK+	BCK-	LRCK+	LRCK-
7	○	●	●	7	DATA-	DATA+	BCK-	BCK+	LRCK+	LRCK-
8	●	●	●	8	DATA+	DATA-	BCK-	BCK+	LRCK+	LRCK-

Figure 2: HDMI I2S Input Diagram

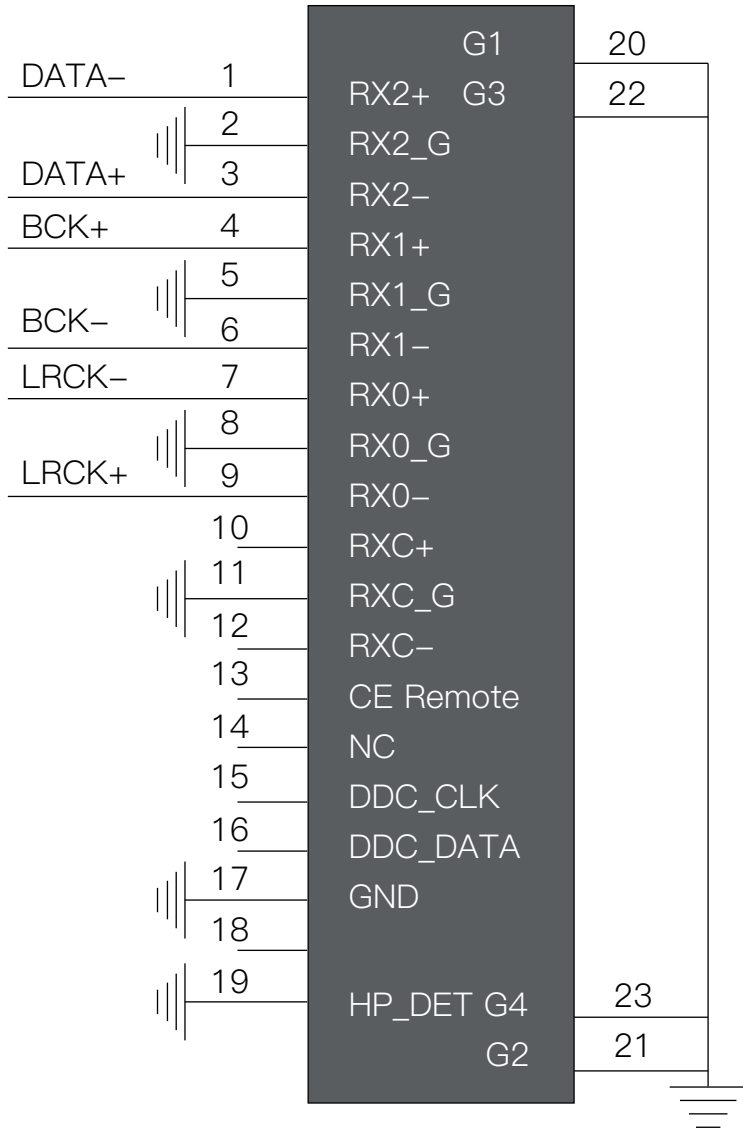
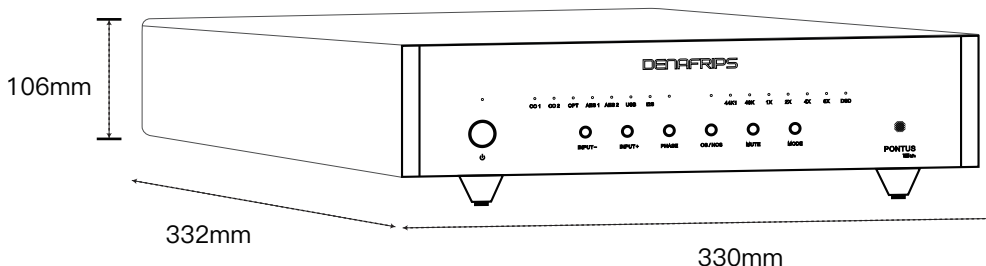

Figure 3



(OPT input test), Table 4

Analog Output Level:	RCA: 2.0Vrms ; XLR: 4Vrms
Analog Output Impedance:	RCA: 625Ω ; XLR: 1250Ω
Frequency Response:	20Hz–83kHz (+1/–3dB)
Total Harmonic Distortion (THD):	<0.0025%(A-weighting)
Signal-to-Noise Ratio (SNR):	≥120dB(A-weighting)
Dynamic Range:	≥121dB
Channel Separation:	≥110dB
AC Power Requirements:	115V/60Hz; 230V/50Hz (Automatic voltage switching)
Total Power Consumption:	≤20W
Unit Dimensions:	330 x 332 x 106 mm(Includes feet)
Outer Packaging Dimensions:	470 x 440 x 175 mm
Packaging Accessories:	Instruction manual and warranty card
Net Weight:	11kg
Gross Weight:	13.35kg

Backplane Interface Introduction

Figure 4

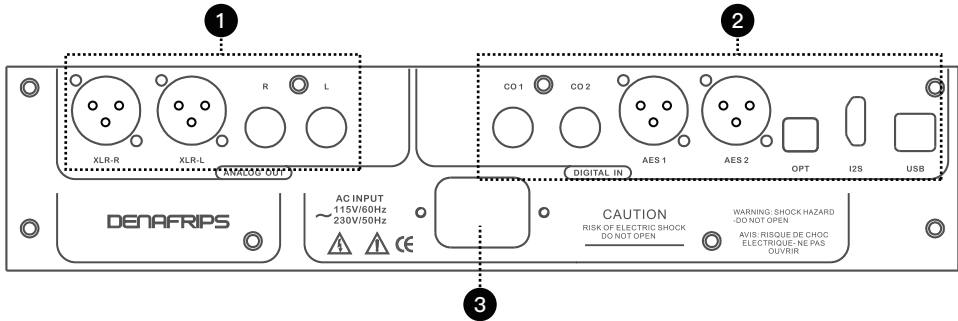

1. Analogue audio signal output area, the unit has a pair of XLR outputs, a pair of RCA outputs, according to your equipment, choose the appropriate output.

XLR-R: Analogue signal right channel balanced output.

XLR-L: Analogue signal left channel balanced output.

RCA-R: Analogue signal right channel balanced output.

RCA-L: Analogue left channel balanced output.

Note: The RCA outputs are connected in parallel to the positive end of the XLRs. In order not to affect your listening experience, we don't recommend you to use the RCA and XLR outputs at the same time.

2. Digital audio input connector area.

This unit has 7 input interfaces, namely CO1, CO2, AES1, AES2, OPT, I2S, USB.

CO1: COAX digital input interface, this interface is RCA interface, input impedance 75 ohms.

CO2: COAX digital input interface, this interface is BNC interface, input impedance 75 ohms.

AES1: Digital balanced input connector, input impedance 110 ohms (the unit can be set up as a single-mode input or as a dual-mode input, see the above function setup description method for details).

AES2: Digital balanced input connector, input impedance 110 ohms (the unit can be set up as a single-mode input or as a dual-mode input, see the above function setup description method for details).

OPT: OPT digital input interface.

I2S: I2S (HDMI standard cable) input interface, different manufacturers wire order may be different, this machine has 8 kinds of wire order to choose from, you can match different manufacturers, see the function of the setup instructions method; Note: Please do not plug and unplug this cable when the machine is in the boot state, be careful of static electricity damage to the product.

USB (Universal Serial Bus) interface: The interface provides convenient digital audio transmission, allowing high-fidelity audio data transfer. It is suitable for connection to PCs, Macs, and various digital audio devices.

③. Power input connector.



This unit is a Class I device, which requires a 3-core power cord, and you need to ensure that the power supply is well grounded; by using the power input connector correctly, you can ensure that the DAC equipment receives stable and reliable power support.

USB Driver Installation

USB Driver Installation – The USB driver is required for Windows operating systems (win10 or above only, for versions below win10 refer to the official website for detailed instructions). The USB driver is licensed by THESYCON and is designed to provide the highest quality audio playback for computer audio systems.

Note: Mac and Linux operating systems do not require a USB driver.

Installation Guide

1. Do not connect the USB cable from your computer to the DAC. unplug it before the USB driver is installed.
2. Download the driver from the support page at <https://www.denafrips.com/download-thesycon>.
3. Double-click the driver on your computer → Follow the on-screen instructions to complete the installation
4. Restart your computer → Connect the USB cable to the DAC → Find the driver icon in the bottom right corner of your computer 
5. Click on the driver icon → select USB Input
6. Click on Playback Devices in the bottom right corner of your computer 
→ Select DENAFRIPS USB DAC as the default sound card for Windows OS.
7. Driver, finish

Solutions to common faults

Table 4

Phenomenon	Solution
A. No sound output	<ol style="list-style-type: none">1. Check that all input and output connection cables are properly connected.2. Check the volume setting of the audio source to ensure that it is not set to mute and that the volume is moderate.3. Replace the data cable or cables to ensure there is no damage.4. Make sure the input source is the same as the panel selection.5. Make sure the unit is not in 'MUTE' state.
B. Noise or murmur	<ol style="list-style-type: none">1. Use the power cord and power adapter to ensure stable power supply.2. Check all connecting cables and interfaces to ensure good contact.3. Try to avoid placing the DAC in areas with high electromagnetic interference, such as near power lines or wireless devices.
C. sound quality distortion	<ol style="list-style-type: none">1. Make sure the sample rate and format of the input signal match the format supported by the DAC.2. Adjust the DAC's filter and decoder settings to select the appropriate sound quality mode.3. Check all signal cables and connectors to make sure the connections are firm and undamaged.

Phenomenon	Solution
<p>D. Device cannot be switched on</p>	<ol style="list-style-type: none"> 1. Check that the power cord and power adapter are properly connected, and make sure there is power to the power outlet. 2. Try restarting the DAC, or reconnecting the power supply after a power failure. 3. If the problem persists, you can contact the manufacturer and we provide detailed solutions.
<p>E. Input signal not recognised</p>	<ol style="list-style-type: none"> 1. Ensure that the format and sampling rate of the input signal matches the format supported by the DAC. 2. Check the input connector and connecting wires to make sure there is no damage or poor contact.
<p>F. The computer cannot recognize the USB device.</p>	<ol style="list-style-type: none"> 1. Ensure that the latest USB driver for the DAC is installed. 2. Check the USB cable and port to make sure the connection is good and undamaged. 3. Try replacing the USB cable or using a different USB port.

After-sales instructions

Dear users: Thank you for purchasing our products! In order to ensure that you get the best experience, please read the following after-sales service related instructions carefully.

1. Warranty

- ①. Warranty period: 1 year free warranty service.
- ②. Warranty contents, table 5

Phenomenon	Solution
a. Warranty period, the product normal use of non-human factors any product quality or functional problems.	Please contact us or your local agent service centre for repair with the serial number on the warranty card. DENAFRIPS offers free repair or replacement parts service and covers all shipping costs.
b. The product is out of warranty and there are any problems with the quality or functionality of the product.	DENAFRIPS offers a paid repair service. If replacement parts are required, only the cost price of the parts (labour is free) and the return logistics costs will be charged.
c. Problems with product quality or function due to improper use or other human factors.	This situation is not covered by the warranty, DENAFRIPS offers a paid repair service, if replacement parts are required, only the cost price of the parts will be charged, labour is free of charge and the user is responsible for the return shipping costs.

- ③. WARRANTY PROCESS: DENAFRIPS has about 30 repair outlets around the world, in order to save shipping costs, the official will co-ordinate with the nearest repair outlets to serve you.

④. The following are not covered by the free warranty

- a. The product has exceeded the specified warranty period from the date of purchase.
- b. The physical product does not match the product model, bar code and date of purchase on the warranty card.
- c. The product has been modified or repaired without the authorisation of DENAFRIPS technical staff.
- d. Damage caused by human factors (e.g. dropping, impact, immersion in water, fire, etc.).
- e. Damage caused by irresistible natural forces (such as earthquakes, floods, lightning strikes, etc.).
- f. Damage caused by exceeding the permitted usage environment.
- g. Damage caused by incorrect use or improper storage (including but not limited to: excessive voltage caused by wiring or component burns; collision caused by the shell or internal device damage; damage caused by excessive dust; product oxidation or corrosion, etc.).

2. Return Policy

- ①. Return conditions: Users can apply for a return within 14 days after receiving the product, if the product has quality problems that are not caused by human damage. Return shipping costs will be borne by the merchant. Please ensure that the product appearance is undamaged, complete accessories, packaging intact, and provide proof of purchase.
- ②. Exchange conditions: During the warranty period, if the product is identified as a quality problem and cannot be repaired, DENAFRIPS will provide an exchange service and bear all the costs.

3. Important Notes

- ①. Please keep your warranty card, it is very important. The serial number of the warranty card is the same as the serial number of the product, which is used as the evidence to enjoy the after-sales service.
- ②. For further information about after-sales policy, please visit our website or contact customer support.

Important protective measures to be aware of



warnings



Risk of electric shock inside the unit. Do not open the cover.

- To minimise the risk of electric shock, do not remove the outer cover (or back cover).
- If repairs are necessary, they should be carried out by qualified service personnel.
- To avoid fire and electric shock hazards, do not allow the unit to get wet or damp.

- ①. **Read Protective Measures**—Before using the equipment, carefully read all warning information in the instruction manual regarding protection and operation.
- ②. **Follow the instructions for use**—Please follow the operation and use information in the instruction manual, and do not operate in violation of the instruction manual.
- ③. **Keep away from water and humidity**—Do not place the unit near water, such as bathtubs, washbasins, sinks, washing machines, etc.; and do not use it in high-temperature and high-humidity environments, such as damp basements.
- ④. **cleanse**—Do not use liquid cleaners and mist cleaners, clean with a dry cloth. Unplug the unit before cleaning.
- ⑤. **power supply**—Please use the power supply according to the labelling of the product. The wiring should be arranged reasonably, please do not step on the line, pulling the power cord, so as not to cause damage. Pay special attention to the wires of plugs, convenient sockets and equipment connections.
- ⑥. **Heat Dissipation**—In order to ensure that the product is used reliably, overheating of the device should be avoided, please do not cover cover the device. Do not use the product on surfaces similar to beds, sofas, carpets and other similar surfaces. If the appliance is installed built-in, such as in a bookcase or on a shelf, make sure there is adequate ventilation. Keep a distance of 10cm (4") on each side, above and behind the appliance. The rear edge of the appliance bracket or upper cover should be 10cm(4") away from the rear panel or wall to allow space for ventilation and heat dissipation.
- ⑦. **Thermal energy**—Keep the product away from heat sources such as radiators, stoves, and other objects that generate heat (including power amplifiers).

- ⑧. **Prevent foreign objects or liquids**—Please avoid allowing objects or liquids to enter the device through any openings, as contact with live components may cause a fire or electric shock hazard. Do not place this device in environments where it may be exposed to rain or splashing liquids, and avoid placing containers with liquids (such as vases) on the device.
- ⑨. **Lightning**—During thunderstorms, please unplug the power cord to effectively prevent damage from lightning strikes.
- ⑩. **Protection**—Disconnect the power plug when the product is not used for a long period of time.
- ⑪. **protect and maintain**—Users themselves should not open the device’s shell to avoid electric shock. In the following cases, if you need repair, please contact the official or professional repair outlets to dismantle the machine.
- ⑫. **Disconnecting device**—When the plug, appliance coupler, and power switch are used as the disconnecting device, ensure easy operation.

DENAFRIPS

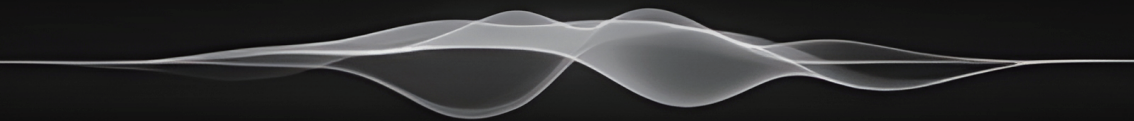

✉ support@denafrips.com

🌐 <https://www.denafrips.com/>

📺 <https://www.youtube.com/@DENAFRIPSAudio>



Facebook